

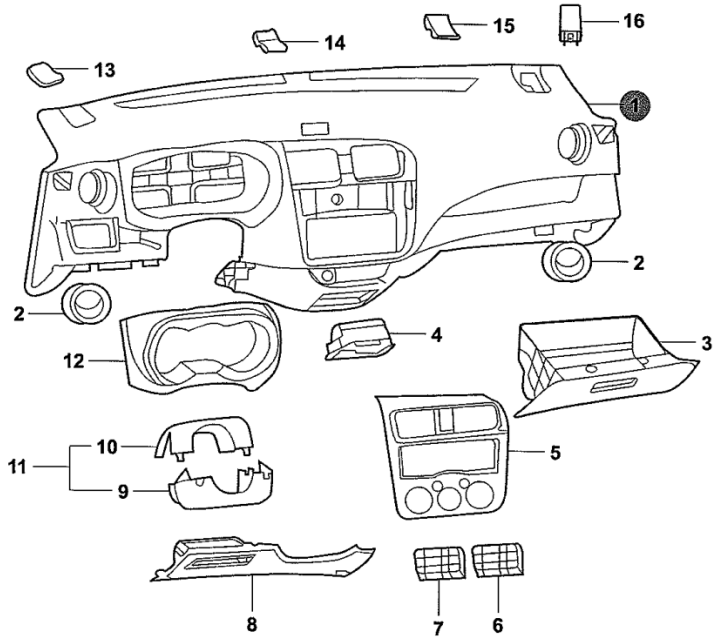

95106-10



95106-10			
INSTRUMENT			
PANEL			
1	M201090-0101	INSTRUMENT PANEL ASSY	1
2	M201090-0200	VENT ASSY, SIDE	2
3	M201090-1101	BOX ASSY, GLOVE	1
4	M201090-1001	ASHTRAY ASSY	1
5	M201090-0900	PANEL, CENTER CONTROL	1
6	M201090-0204	VENT ASSY, CENTRAL, RH	1
7	M201090-0203	VENT ASSY, CENTRAL, LH	1
8	M201090-0701	LOWER COVER, INSTRUMENT PANEL, LH	1
9	M201090-0500	STEERING COVER, LOWER	1
10	M201090-0400	STEERING COVER, UPPER	1
11	M201090-0301	COVER, STEERING LOCK	1
12	M201090-0300	COVER, COMBINATION METER	1
13	M201090-1400	CAP, INSTRUMENT PANEL	1
14	M201090-1500	CAP, INSTRUMENT PANEL	1
15	M201090-1600	CAP, INSTRUMENT PANEL	1
16	Y036-150	FLASHER ASSY	1
17	M201090-1011	LIGHTER, CIGARETTE	1

2013-05